

**AQUACULTURE LICENCE NO. 78**  
**GRANTED UNDER THE FISHERIES (AMENDMENT) ACT, 1997 (NO. 23)**

AGREEMENT made the 1st day of June, 1999, between the Minister for the Marine and Natural Resources (hereinafter referred to as the " Minister " ), of the one part, and

**DEREK ROWLEY**  
**NEW ROOSKEY**  
**ROOSKEY**  
**CO ROSCOMMON**

(hereinafter referred to as the "Licensee") of the other part, whereby the Minister in exercise of the powers conferred on him by the Fisheries (Amendment) Act, 1997 (No. 23) grants an Aquaculture Licence for the culture of bream, carp and tench at Rooskey, Co Roscommon, (outlined on the attached map and coloured red) in accordance with plans approved of by the Minister, subject to the provisions of the Act referred to and to the terms and conditions set out in the Schedule attached.

Subject as aforesaid, this Aquaculture Licence shall remain in force for a maximum of 10 years from the 1st day of June, 1999.

## SCHEDULE

### **TERMS AND CONDITIONS TO APPLY TO 10 YEAR AQUACULTURE LICENCE FOR CULTURE OF BREAM, CARP AND TENCH BY DEREK ROWLEY AT ROOSKEY, CO ROSCOMMON**

#### General

1. Subject to the provisions of the Fisheries (Amendment) Act 1997, the Licence shall remain in force for so long as there is in force a planning permission granted by Roscommon County Council (or An Bord Pleanála) in respect of the fish farm, subject to a maximum of 10 years from the date of grant.
2. The Licensee shall comply with such instructions as the Minister may issue from time to time for the proper management and control of all fish culture activities at the fish farm, including in particular instructions issued in relation to any of the matters referred to in the following paragraphs.
3. The Licensee shall indemnify and keep indemnified the State, the Minister, their officers, servants or agents against actions, loss, claims, damages, costs, expenses and demands arising in any manner whatsoever in connection with the construction, maintenance or use of any aquaculture structures, apparatus or equipment in the exercise of rights granted under the Licence.
4. The Licence shall not be construed as authorising the Licensee in any way to interfere with or infringe the rights of any other person.
5. (a.) In the event of neglect or abandonment of the fish farm, the Minister shall take such action as he thinks fit (including the disposal of any fish there and revocation of the Licence) and the Licensee shall be liable to reimburse the Minister the expense involved in so doing.  
  
(b.) The Minister shall be at liberty at any time to revoke or amend the Licence if he considers that it is in the public interest to do so, or if he is satisfied that there has been a breach of any condition specified in the Licence, or in the event of water quality results or general performance at the fish farm not meeting the standards set by the Department of the Marine and Natural Resources. Any such revocation or amendment shall be subject to the provisions for the Fisheries (Amendment) Act, 1997, or any amendment thereto.

#### Stocking, etc, restrictions

6. No fish other than bream, carp and tench shall be stocked, bred or handled at the fish farm.
7. The standing stock of fish held at the farm shall not exceed a maximum biomass weight of 40 tonnes at any time; any excess over 40 tonnes shall be removed forthwith and appropriately dealt with, with the approval of the Shannon Regional Fisheries Board.

8. Such precautions shall be taken as the Minister may specify from time to time, in relation to
- (a) the introduction of fish for stocking the fish farm, including disease-free certification, and
  - (b) the adaptation of methods of operation or type of installation.

### **Hygiene and Fish Health**

9. The Licensee shall make adequate arrangements for the hygienic operation of the fish farm at all times (including the proper selection and preparation of food, and the proper treatment and disposal of wastes).
10. The Licensee shall provide and maintain such gratings or other devices at the point of water abstraction from natural water courses adjoining the fish farm and also at a point as near as possible to the confluence of the fish farm waste channel and the natural water courses as will effectually prevent the admission of migratory fish into the fish farm feed channels, the fish farm waste channel and other water courses and ponds of the fish farm, and shall make adequate arrangements to ensure the safe passage past the fish farm of migratory fish, and shall make all necessary provisions to prevent the escape of fish from the fish farm.
11. The Licensee shall ensure that the abstraction of water by the fish farm shall be so regulated that sufficient water will be maintained at all times in the natural water courses adjoining the fish farm to ensure the free passage of migratory fish past the fish farm.
12. The Licensee shall fit adequate anti-predator netting on fish farm structures so as to prevent predation and the possible spread of disease by predators.
13. The Licensee shall carry out regularly water quality monitoring at the fish farm and provide the results of such monitoring to the Department of the Marine and Natural Resources on request.
14. All chemicals, antibiotics and disinfectants used on the fish farm shall be used in accordance with instructions issued by the Minister from time to time.
15. The Licensee shall keep full records of all chemicals, antibiotics and disinfectants with which fish are treated on the fish farm, including details of quantities used and times of use.
16. The Licensee shall notify the Coastal Zone Administration Division, Department of the Marine and Natural Resources, Leeson Lane, Dublin 2, within 24 hours of the appearance or suspected appearance of any disease or parasite or abnormal losses or mortalities at the fish farm and shall send samples to the Fish Pathology Unit, Fisheries Research Centre, Marine Institute, Abbotstown, Castleknock, Dublin 15, in the prescribed manner as and when requested to do so, and shall comply with any directions by the Department as to the treatment, disposal or destruction of stocks of fish at the fish farm in the interests of safeguarding the stocks of other fish in the State.

17. The Licensee shall make arrangements for the disposal of dead fish in a manner approved of by the Minister and to Roscommon County Council.
18. The Licensee shall notify the Coastal Zone Administration Division, Department of the Marine and Natural Resources and the Fish Pathology Unit, at the above address, and the Shannon Regional Fisheries Board within 24 hours of any escapes of fish from the fish farm and shall keep full records of fish escaped, including records of numbers, origin, types and year classes, and shall make these records available to the Department, the Fish Pathology Unit and to the Shannon Regional Fisheries Board on request.

**Inspections, records and returns**

19. The fish farm and all structures and equipment used in connection with the operations of the fish farm shall be open to inspection at any time by any authorised officer within the meaning of the Fisheries Acts.
20. The Licensee shall keep full records at the fish farm of all fish introduced into, stripped, bred, held or handled at the fish farm and of all sales of fish from the fish farm and such records shall be available for inspection at all reasonable times by any inspector appointed for any purpose of the Fisheries Acts.
21. The Licensee shall furnish to the Coastal Zone Administration Division, Department of the Marine and Natural Resources, at the above address, such returns from the records kept at the fish farm as may be required from time to time.

**PRESENT** when the Seal of Office  
of the **MINISTER FOR THE MARINE  
AND NATURAL RESOURCES**  
was affixed and was authenticated  
by the Signature of:

**THOMAS J. TOBIN**

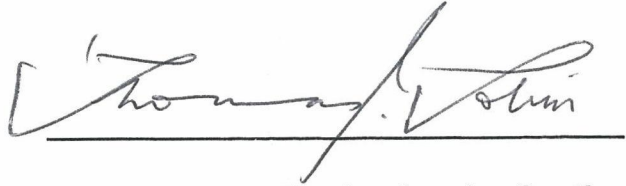

A person so authorised under Section  
15(1) of the Ministers and Secretaries  
Act, 1924 to authenticate the seal of  
the Minister.

**WITNESS:** horraine Hughes

**ADDRESS:** Department of Marine &

Natural Resources, Heuston Lane, Dublin 2

**OCCUPATION: CIVIL SERVANT**

**SIGNED** on behalf of Licensee

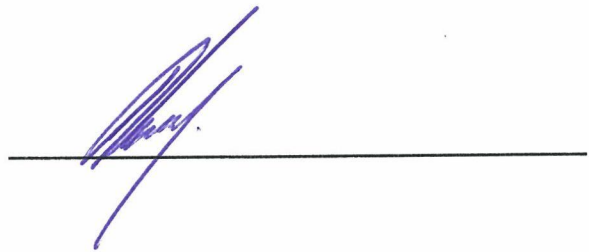

in the presence of:

**WITNESS:** Mary Rowley

**ADDRESS:** New RoosKEY

RoosKEY, Co. Roscommon

**OCCUPATION:** BANK OFFICIAL.

Townland - Roodkey Hill.  
0.3 Ha. 34 \* SPRINGS



Site Area

# SECTION A OF AREA

**SITE LAYOUT MAP 2**  
 Site outlined in Red  
 Scale: 1/500  
 Revised: 3<sup>rd</sup> May 1996

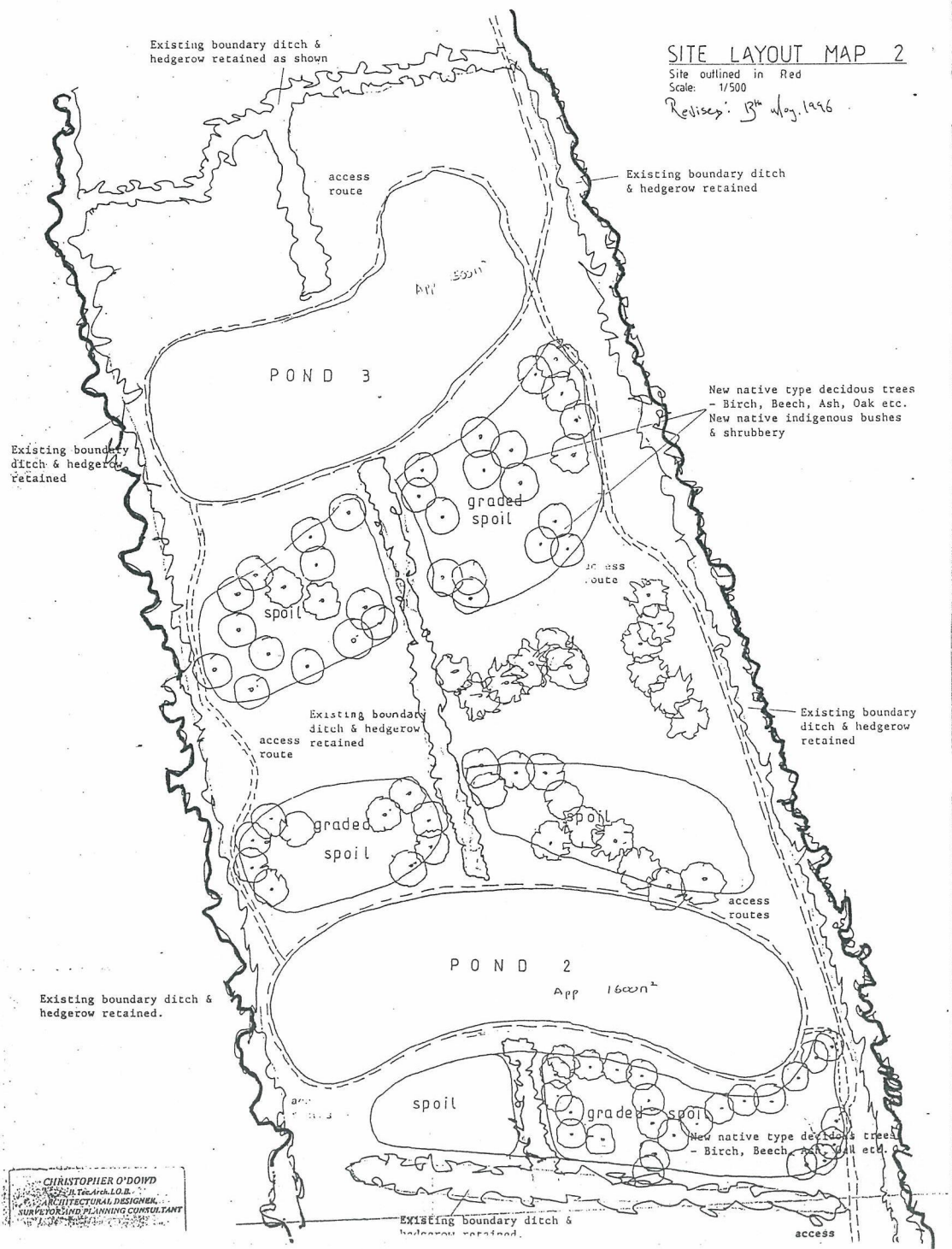
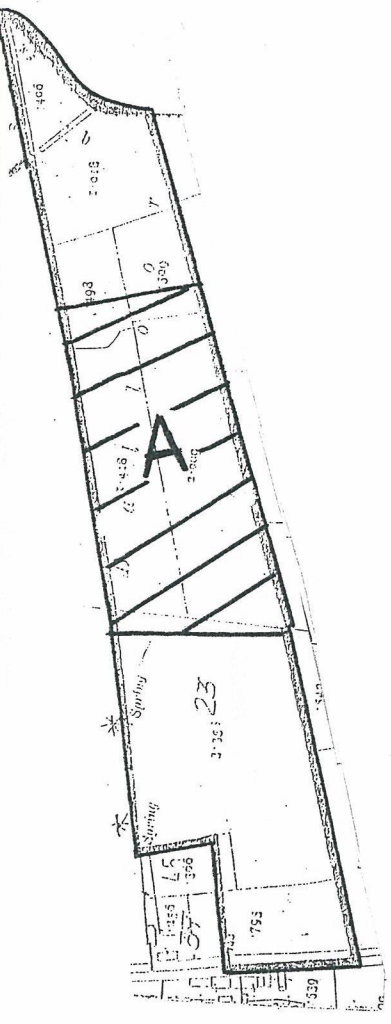
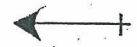

**CHRISTOPHER O'DOYD**  
 ARCHITECTURAL DESIGNER  
 SUPERVISOR PLANNING CONSULTANT

# SECTION B OF AREA

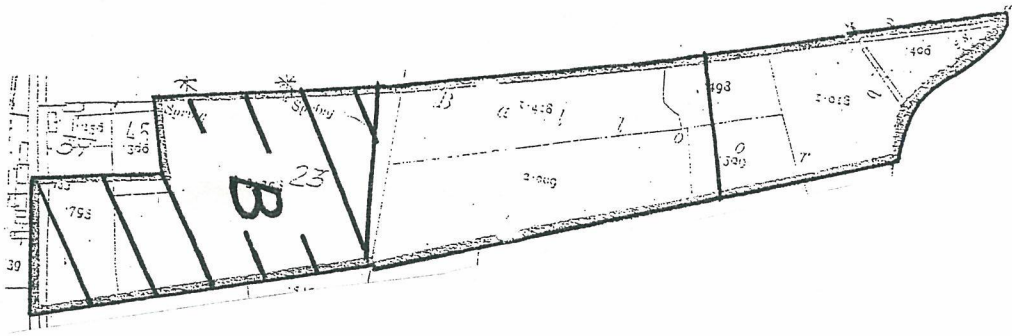

CHRISTOPHER O'DONN  
 ARCHITECTURAL &  
 ENVIRONMENTAL PLANNING CONSULTANTS  
 1525 KALANANU'U DRIVE  
 HONOLULU, HAWAII 96813  
 TEL: 808-943-1111  
 FAX: 808-943-1112

**SITE LAYOUT MAP 1**  
 Site outlined in red  
 Scale 1/8" = 1'-0"  
 Revises 15<sup>th</sup> May 1996

Note: Proposed screen planting - new native type deciduous trees - Birch, Beech, Ash, Oak etc.

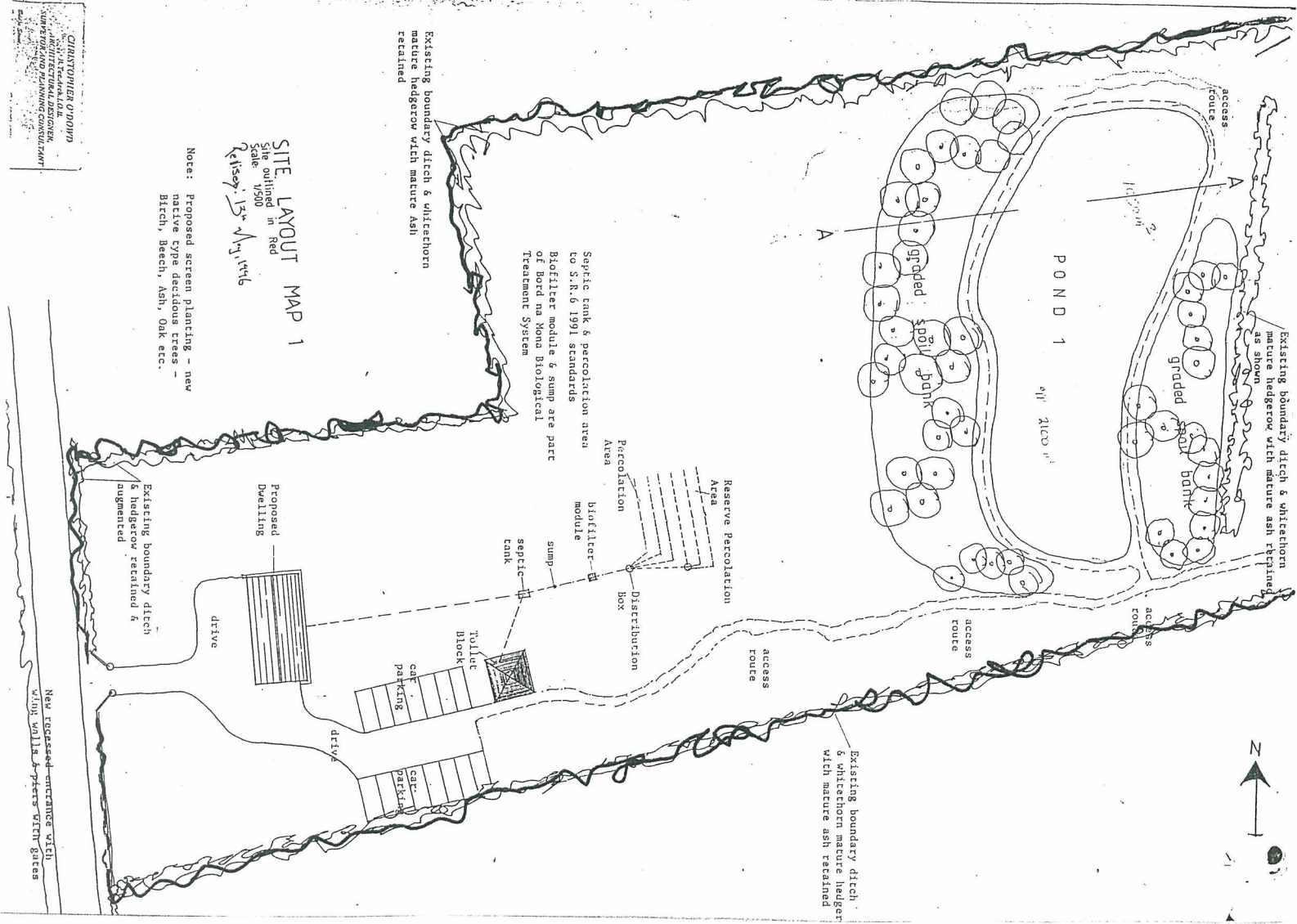

Existing boundary ditch & whitehorn mature hedgerow with mature ash retained

Existing boundary ditch & whitehorn mature hedgerow with mature ash retained

Septic tank & percolation area to S.R.6 1991 standards  
 Biofilter module & sump are part of Bord na Kona Biological Treatment System

Existing boundary ditch & hedgerow retained & augmented

New Egged-encirance with white walls & gates with gates